



Pilous

Železná 9, 619 00 Brno, Czech Republic

Tel.: +420 543 25 20 10

e-mail: metal@pilous.cz, www.pilous.cz

Dynamic 2.6

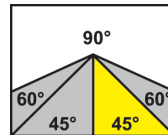

2880 x 27 x 0,9

	90°	+45°
●	260	180
■	245	170
■	270 x 210	180 x 120

Main motor	400 V, 50 Hz, 2,2 kW
Pump motor	400 V, 50 Hz, 0,12 kW
Hydraulic motor unit	400 V, 50 Hz, 0,55 kW
Feed rate of material	1,8 / 4,2 / 6,6 m/min.
Saw blade speed	15-90 m/min.
Working height of vice	870 mm
Hydraulic system oil	cca 26 l (ISO 6743/4-HM, DIN 51 524 part 2-HLP)
Coolant tank	cca 35 l
Machine dimensions	Dimension drawing
Machine weight	870 kg

DESCRIPCIÓN DEL PRODUCTO

Simpler, affordable, yet extremely powerful, accurate and robust. This fully automated band saw with CNC finds general application in series cutting. The machine features proportionally controlled hydraulic material feed. The machine can be controlled in fully automatic, semi-automatic or manual mode. In manual mode all functions of the machine are controlled separately. The maximum length of a single feed is 500 mm. Continuous manual adjustment of the cut angle in the range of 90-45 °. The saw can cut material at an angle even in automatic mode. The hydraulically controlled robust feeding vice moves on hard-chrome bars. The linear measuring system guarantees high measuring accuracy. High feed speed controlled by proportional equipment, CNC-controlled acceleration and deceleration process helps achieve a feeding accuracy of 0.1 mm. Smooth deceleration in the end positions also prevents slippage of heavy materials.

The central control panel with a large colour touch screen (7.5") guarantees very easy control of the machine using a proprietary operating system. You only enter the desired length and quantity. Material clamping and the movement of the band saw arm to the cut and back to the desired position according to the material cross-section are also controlled hydraulically. Pressure control of the feeding vice and the fixed vice as standard. Maximum cutting efficiency is maintained also thanks to the possibility of setting optimum saw band rate by a frequency converter in the range between 15 and 90 m/min., which significantly contributes to cutting accuracy and service life of saw bands.

The maximum material feed accuracy results from the robust design of the machine with all main parts made of grey iron and the sturdy design of the feeding system. The base design and the entire sturdy structure ensure an exceptional stability of the machine, even when cutting heavy workpieces. The base is equipped with a large removable chip container and allows the installation of a screw chip conveyor. The 27x0.9 mm industrial saw band is produced in many variants and enables industrial splitting of a wide range of materials, including stainless steel or tool steel. The latest concept of the arm casting with cavities is fitted with running wheels with an optimal diameter. The larger diameter of the wheels ensures less bending stress of the saw band. All this ensures an outstanding rigidity of the whole system, long service life of saw bands and maximum cut precision. All electrical wiring and the coolant delivery system are concealed in hollow parts of the arm, which means they are protected from damage. The new concept of the arm also brings a great simplification when changing the saw band or when cleaning the inside of the arm. You just need to open the hinged back cover of the arm and it will stay locked in the upper position.

Apart from creating an entirely new design of the arm, we also made many technical adjustments and changes improving the quality, user comfort and service life of the machine. As an accessory, it is possible to use the cleaning brush of the saw band that is synchronously driven by the driving wheel. Simple intuitive control using ergonomically positioned controls on a separate central control panel. The very robust machine framework composed of grey iron castings guarantees safe vibration absorption. The modern concept of the band saw arm allows large cutting ranges in perpendicular as well as angular cuts. Optimal-diameter running wheels and precise three-side hardened steel blade guides ensure long service life of the band and cutting accuracy. The optimal fit of the running wheels, the tensioning system and all rotating parts increases the service life of the machine. Noiseless and maintenance-free drive of the saw band is provided by an industrial electric motor with a worm gearbox. Check of the correct tension or tear of the saw band. When the saw band breaks, the machine automatically stops. The machine is connected to a complete cooling system with a powerful pump, enabling separate flow control on both guide heads and another adjustable outlet. The emulsion tank with a powerful pump is located in the machine base.

GALERÍA DE IMÁGENES

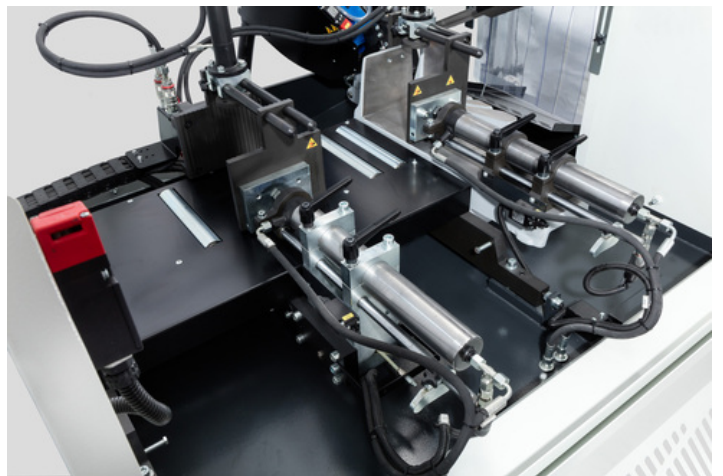
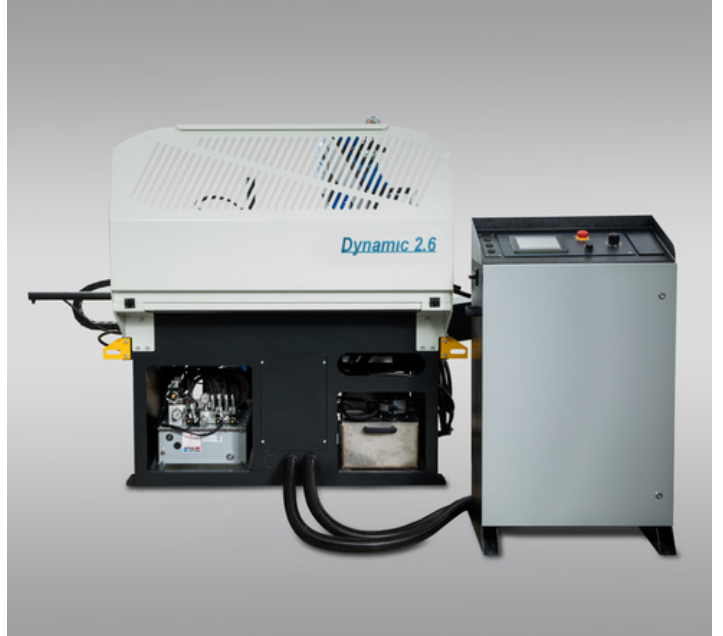

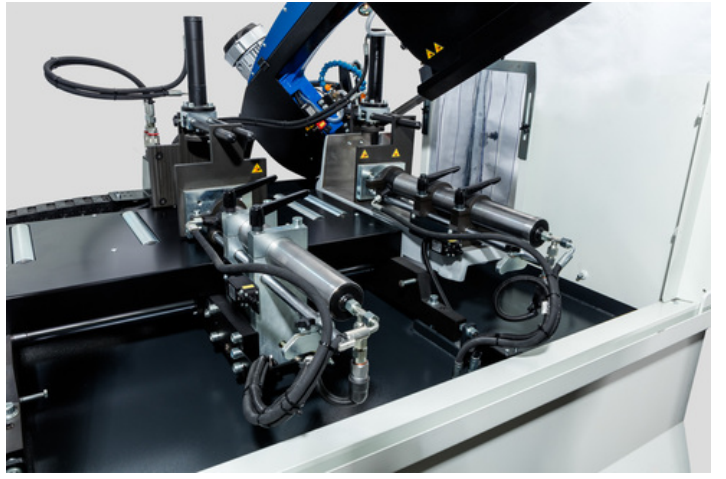
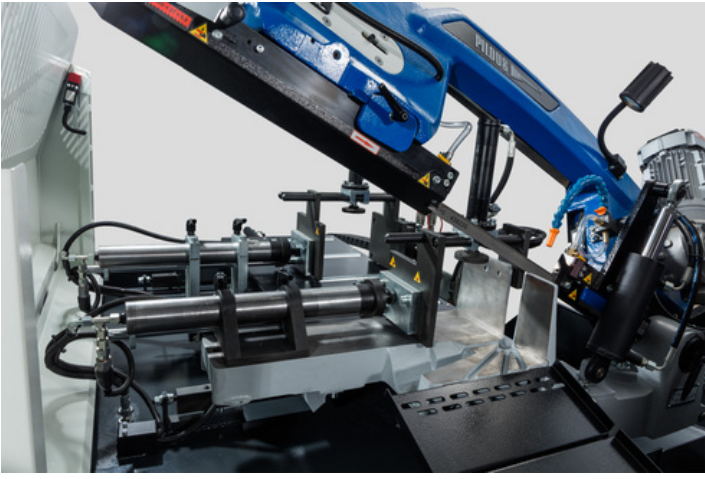



FR*

Convertidor de frecuencia - equipamiento estandar

Permite regular continuamente la velocidad de la cuchilla entre 15-90 m/min. y establecer así las condiciones de corte óptimas para el material de que se trate.



HVP NC 250/300/330

Dispositivo de presión hidráulica HVP

Sirve para sujetar el material durante el corte en paquete. Asegura una sujeción fiable mediante presiones verticales controladas hidráulicamente, que funcionan en ciclo con toda la máquina. Está instalado en el tornillo fijo y de alimentación.

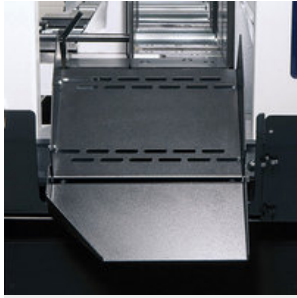

KL

Vertedero de material KL

Une continuamente el tornillo de banco detrás del corte y permite deslizar fácilmente las piezas cortadas en un contenedor cuando se cortan series más grandes. La construcción de la conducto, que consta de 2 partes, evita las fugas del refrigerante.



LA 50

Lámpara halógena LA

Proporciona una buena iluminación del lugar de trabajo de la máquina. Una herramienta invaluable, especialmente cuando la iluminación del lugar de trabajo es insuficiente.



MM

Lubricación por neblina de aceite MM

Crea una niebla de aceite que se pulveriza sobre el filo de corte. Sustituye al uso de un refrigerante clásico, especialmente al cortar secciones durante las cuales pueden producirse fugas. Posibilidad de utilizar aceites ecológicos.



LS

Alineación láser LS

El láser industrial de alta calidad proyecta la línea de corte sobre el material a cortar. Hace que el ajuste de la longitud de material requerida sea más sencillo, rápido y preciso.



KDM

Cepillo de limpieza KDM

Cepillo de limpieza de acero, accionado por rueda motriz. Se utiliza para eliminar virutas de la cinta de sierra detrás del corte.

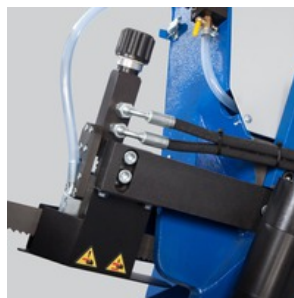

AG 330/380/400

Pressure regulation

Hydraulically controlled one-sided automatic regulation of saw band feed into cut according to the resistance of the material to be cut. Significantly reduces the cutting time and service life of the saw band.

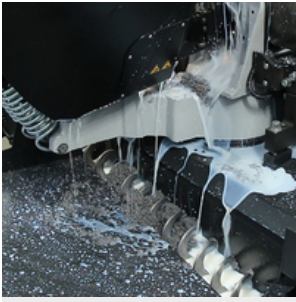

SD

Transportador de virutas SD

Asegura la eliminación continua de virutas fuera de la máquina. Reduce el tiempo necesario para limpiar la máquina, especialmente durante el corte en serie de materiales sólidos, donde se genera una gran cantidad de virutas.



CD

Indicador de tensión de la cinta de sierra CD

Garantiza un tensado preciso de la cinta de sierra al valor requerido según el manómetro y su control durante el uso de la máquina. La tensión óptima de la cinta de sierra es esencial para su vida útil y su precisión de corte.



OPL

Pistola de enjuague OPL

Sirve para limpiar el área de trabajo de la máquina.



SDB

Contenedor de virutas SDB

Para una fácil manipulación, el contenedor está equipado con ruedas y un depósito basculante para virutas.

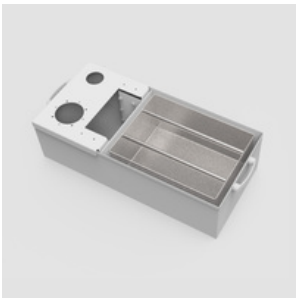

ST separator

Separador de virutas ST

Un recipiente galvanizado y finamente perforado que sirve para la recolección eficiente de las virutas que pasan por el tamiz en la base. Este recipiente es fácilmente extraíble cuando está lleno y se puede limpiar fácilmente fuera de la máquina.



STM magnetic separator

Separador magnético de virutas STM

Para virutas especialmente finas que pasan por los tamices en la sierra, se utiliza un separador magnético altamente eficiente. Ahorra tiempo de limpieza y desmontaje del sistema de refrigeración y prolonga la vida útil del refrigerante. Este dispositivo es fácilmente extraíble y se puede limpiar fuera de la máquina simplemente retirando las barras magnéticas de la carcasa.

TRANSPORTADORES

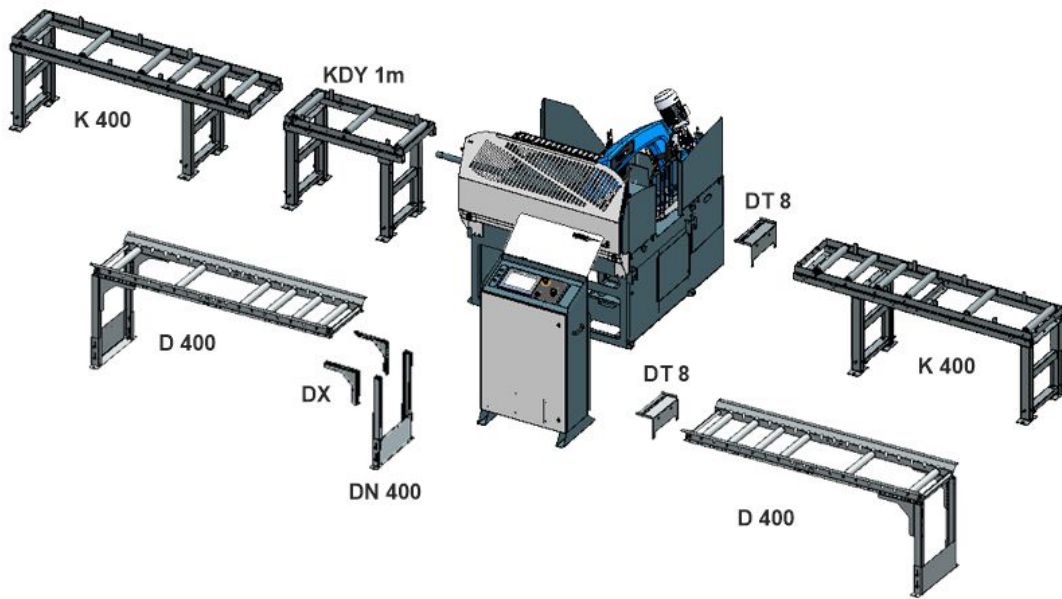



- Original bandsaw blades produced using the latest technology with top-quality German materials, while strictly complying with all stated production and control procedures.
- High productivity and precision of cut with the maximum service life of the blade is ensured.
- Wide range of produced types of sawblades and tooling enables the professional cutting of almost all available materials.

Bi-metal blade
Consists of bearing band from special steel on which a layer of HSS material is welded into where the teeth are milled.

Constant toothting
The distance of the teeth are always the same.

Variable toothting
The distance of teeth vary and is periodically repeated. This results in a greater cutting range, ability to further eliminate vibrations caused by the impact of the tooth blade on material, longer service life of the blade.

M42

Universal blade recommended for a wide palette of material, including tool steels and stainless steel up to hardness 45 HRC. Teeth are made from steel HSS-M42 containing cobalt.

M51

Blade for tool and stainless steel with hardness up to 50 HRC. Tooth tips are made from steel HSS-M42 containing cobalt and wolfram

Carbide

Consists of bearing band from special steel into which the teeth are milled on which especially grinded carbide plates are welded. The carbide mounted blade is recommended for cutting surface hardened materials, chrome parts, forged pieces and materials with external tenacity and hardness up to 62 HRC.

Cutting range

For optimal output of the blade, the correct selection of the size of the blade tooth is important depending on the size of the divided material.

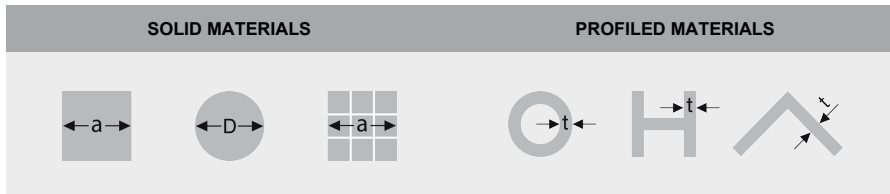

Variable toothting		Constant toothting		Variable toothting		Constant toothting	
a(D) [mm]		a(D) [mm]		t [mm]		t [mm]	
0-25	10/14	0-10	18	0-4	10/14	0-1	18
20-40	8/12 (8/11)	5-20	14	3-6	8/12 (8/11)	0-3	14
30-60	6/10	20-40	10	6-9	6/10	4-7	10
40-70	5/8 (5/7)	40-80	6	9-13	5/8 (5/7)	8-11	6
60-110	4/6	80-120	4	12-16	4/6	12-15	4
80-140	3/4	120-200	3	16-22	3/4	16-20	3
120-350	2/3	200-400	2	20-35	2/3	21-30	2
250-550	1,4-2	300-800	1,25	30-85	1,4-2	31-90	1,25
380-750	1/1,5			40-85	1/1,5		
550-3000	0,75/1,25			80-200	0,75-1,25		

When selecting the number of teeth for the blade, the general principle applies of a minimum of 4 teeth, but no more than 30 teeth are in contact with the work piece.

Be careful when unpacking welded saw blades. They are in a shipping container in tensioned condition. Remove the saw blade cover only after fitting it onto the machine.



COOLcut Standard

COOLcut Standard – universal coolant and lubricant.

Recommended concentration 5–10 %. 5 litres pack. Dilution 1:20.

- fluid allows achievement of optimal lubricating and cooling properties during the machining process
- low aromatic, highly refined paraffinic oil
- effective corrosion inhibitors provide permanent protection of the workpiece and the machine from corrosion
- bio stability and excellent wettability ensure excellent cooling and lubricating effect even in very hard water
- minimum tendency to foaming ensures effective lubrication
- high efficiency and profitability of use

Except use on log band saws the product is designed for machining operations carried out both on conventional machines and NC and CNC machining centres.



COOLcut Opti

COOLcut Opti – universal coolant and lubricant. Such machining fluid allows achievement of unique lubricating and cooling properties during the machining process.

Recommended concentration 4–7 %. 1 and 5 litres pack. Dilution 1:20.

- low aromatic, highly refined mineral oil
- effective corrosion inhibitors provide permanent protection of the workpiece and the machine from corrosion
- above average stability and excellent wettability ensure excellent cooling and lubricating effect even in very hard water
- minimum tendency to foaming ensures effective lubrication
- high efficiency and profitability of use
- long-term biostability

In addition to use in saw bands the product is designed for machining operations carried out both on conventional machines and NC and CNC machining centres.



COOLcut Eco 65

COOLcut Eco 65 – universal cooling and lubricating emulsifying oil, well biodegradable according to OECD 301-D test. Biodegradability of 65 % in 21 days.

Recommended concentration 4–7 %. 5 litres pack. Dilution 1:20.

- Such machining fluid allows achievement of unique lubricating and cooling properties during the machining process
- highly refined synthetic ester oil
- effective corrosion inhibitors provide permanent protection of the workpiece and the machine from corrosion
- above average stability and excellent wettability ensure excellent cooling and lubricating effect even in very hard water
- minimum tendency to foaming ensures effective lubrication
- high efficiency and profitability of use
- long-term biostability

In addition to use in saw bands the product is designed for machining operations carried out both on conventional machines and NC and CNC machining centres.



COOLcut Bio 90

COOLcut Bio 90 – universal cooling and lubricating emulsifying oil, well biodegradable according to OECD 301-D test. Biodegradability of 90 % in 21 days. Due to its biodegradability it can be used in any outdoor environment without environmental damage.

Recommended concentration 4–7 %. 5 litres pack. Dilution 1:20.

- Such machining fluid allows achievement of unique lubricating and cooling properties during the machining process
- highly refined synthetic ester oil
- effective corrosion inhibitors provide permanent protection of the workpiece and the machine from corrosion
- above average stability and excellent wettability ensure excellent cooling and lubricating effect even in very hard water
- minimum tendency to foaming ensures effective lubrication
- high efficiency and profitability of use
- long-term biostability

In addition to use in saw bands the product is designed for machining operations carried out both on conventional machines and NC and CNC machining centres.



COOLcut Micro

COOLcut Micro – an easily biodegradable semi-synthetic cooling and lubricating micro-emulsion. Due to its biodegradability it can be used in any outdoor environment without environmental damage. Such machining fluid allows achievement of unique lubricating and cooling properties during the machining process.

Pack of 5 litres. Use undiluted.

- highly refined synthetic ester oil
- effective corrosion inhibitors provide permanent protection of the workpiece and the machine from corrosion
- above average stability and excellent wettability ensure excellent cooling and lubricating effect even in very hard water
- minimum tendency to foaming ensures effective lubrication
- high efficiency and profitability of use
- long-term biostability

In addition to use in saw bands the product is designed for machining operations carried out both on conventional machines and NC and CNC machining centres. 5 litres pack.



COOLcut Antifreeze

COOLcut Antifreeze – low-freezing ingredient for water miscible coolants used in winter in outdoors environment, up to minus 20 °C, depending on the dosage.

5 litres pack. Dilution 1:20.

- effectively lowers the freezing point of the fluid
- very good resistance to oxidation guarantees long service life
- does not act aggressively on the sealing elements (elastomers), to which it comes into contact.

Optima Antifreeze	(%)	10	20	30	40	50
Flowability temperature	(°C)	-5	-10	-17	-26	-40

RECOMENDADOS



OH 90

Simple and very fast deburring of all kinds of sections (including the internal edges) or full material by a rotary steel brush. High quality construction of the machine along with a three-phase motor make use of the machine possible in specialized workshops as well as in production plants. Compared to manual deburring it reduces the required time and hence reduces your costs. While maintaining incomparably higher and balanced quality of deburring.

We recommend using stainless steel brush for stainless steel products.
Example of the difference between manual deburring (including internal edges) and OH 90

Hollow section 60 x 60 x 2 mm:	manual deburring - 32 s	machine OH 90 - 8 s
Tube diameter 50 x 2 mm:	manual deburring - 21 s	machine OH 90 - 4 s



OHE 90

Simple and very fast deburring of all kinds of sections (including the internal edges) or full material by a rotary steel brush. High quality construction of the machine along with a three-phase motor make use of the machine possible in specialized workshops as well as in production plants. Compared to manual deburring it reduces the required time and hence reduces your costs. While maintaining incomparably higher and balanced quality of deburring.

We recommend using stainless steel brush for stainless steel products.
Example of the difference between manual deburring (including internal edges) and OH 90

Hollow section 60 x 60 x 2 mm:	manual deburring - 32 s	machine OH 90 - 8 s
Tube diameter 50 x 2 mm:	manual deburring - 21 s	machine OH 90 - 4 s